



COMPANY PROFILE



CONTENTS

THE BAQAR SHADES DIFFERENCE	1
MODULAR SHADE STRUCTURES	3
TENSOCAR CARPARK SHADE	9
TENSONET HAIL PROTECTION	11
TENSOCOLA SCHOOL CANOPY	13
TENSOSPORT CANOPY	14
TENSOSPORT-MAX CANOPY	15
VELARIUM VARIABLE SHADE SYSTEM	18
DESIGN FLEXIBILITY	19
REPAIRS, REPLACEMENTS & MAINTENANCE	20
INDUSTRY APPLICATIONS	21
ARCHITECTURAL FABRIC COMPARISON	22
About US	23



THE BAQAR SHADES DIFFERENCE

Offering a superior range of shade solutions, Baqar Shades specialise in lightweight fabric structures with a signature high-level architectural style for a variety of applications and industries.

Baqar Shades has extensive experience delivering a wide-range of quality tensile membrane structures by combining cutting-edge modern architectural fabrics such as PTFE, PVC and HDPE, with our proprietary TensoShade membrane fixing system that has been engineered for premium quality, ease of installation and tensioning, and maximum durability.

FAR FROM STANDARD

In addition to bespoke projects, Baqar Shades has developed our own range of Standard and Modular Shade Structures. Far from being 'standard', our range of core products are the result of 23 years of extensive design and engineering experience and expertise.

The advantages of choosing a Baqar Shades & Tenta

- » Through years of experience delivering successful tensile membrane projects, we know what works.
- » With the main elements pre-engineered and designed in advance, we cut down on project delivery time.
- » Ideal for smaller to medium-sized projects that still require a premium-quality permanent shade structure, by using products from our Standard or Modular Range, you can save time and money on the design and installation phase of your project.
- » Future-proof projects; our standard designs make it easier to re-skin, repair or expand in years to come.
- » Easily adapted to meet your needs, each structure is still tailored to take into account the particular details of your project, location or business requirement.

DESIGN. ENGINEER. FABRICATE. INSTALL.

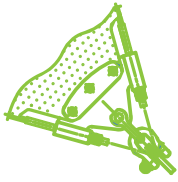

Baqar Shades is the market leader in the design, engineering, fabrication and installation of architectural tensile membrane structures. We provide quality shade and weather solutions

for retail and commercial developments, hospitality and entertainment venues, sports and recreation centres, community spaces, schools, transport hubs, mining and industrial sites, and more.

Our Standard and Modular Fabric Structures are built to withstand the harsh Saudi Arabia environment, with the longest life-span and lowest maintenance costs on the market.

Our in-house design team works collaboratively with you to create and deliver your project vision. Design, function, constructability and aesthetic considerations are at the forefront of all our standard design details.

Offering a range of installation options, from complete 'turn-key' solutions, to working in partnership with your preferred builder or construction company, our expert project managers deliver on the construction of the project to ensure minimal impact on your venue's activities. Our work can even be planned around your operating hours to ensure any disruption to your business is minimised.

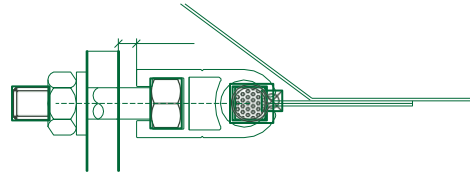
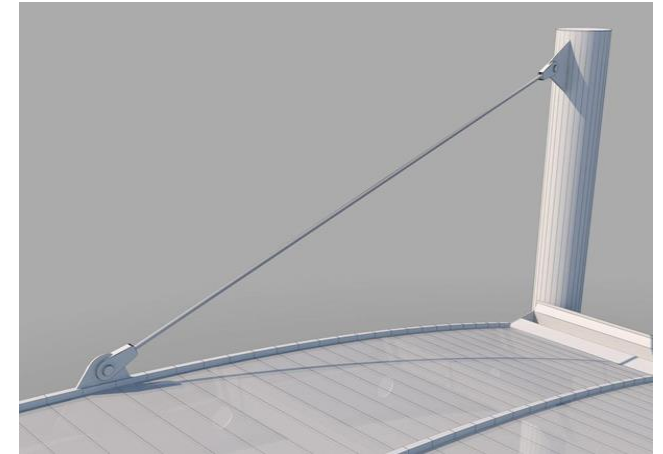

MONACO MODULAR UMBRELLA

Our most popular and versatile modular shade structure, Monaco Modulares are umbrella-style shade structures and are ideal for tourism and hospitality applications, as well as community shade projects in public parks, recreation spaces and pedestrian areas.

Square as standard, the Monaco canopy can be supported by either a central column or external cantilever column.



Designed as a permanent, non-collapsible umbrella-style shade structure, Monaco are engineered to be well suited to higher wind speeds.

- » Multiple units can be linked together to increase the shade and weather protected area.
- » Available in Contour Edge and Linear Edge.
- » Engineered as a permanent shade structure, Monaco Modular Umbrellas are designed for any Saudi Arabia wind speed.
- » Completely weather-proof, Monaco Modulares include galvanised steel cables with stainless steel fittings and a UV stabilised membrane.
- » Available with a range of accessories, such as LED lighting and heating.
- » Roll-down blinds and gutters can also be fitted to Monaco Linear Edge models.



STANDARD SIZES

Single canopies range from 3m x 3m to 12m x 12m. Linking units together can create larger coverage.

CANOPY SHAPE / COLUMN	CANOPY SIZE	MODEL NUMBER
	m	Code (L-Linear Edge)
 CENTRE COLUMN	3 x 3	MS30 / MS30L
	4 x 4	MS40 / MS40L
	5 x 5	MS50 / MS50L
	6 x 6	MS60 / MS60L
	7 x 7	MS70 / MS70L
	8 x 8	MS80 / MS80L
	9 x 9	MS90 / MS90L
	10 x 10	MS100 / MS100L
 CANTILEVER COLUMN	4 x 4	MSS40 / MSS40L
	5 x 5	MSS50 / MSS50L
	6 x 6	MSS60 / MSS60L

STANDARD SHAPES



LINEAR EDGE

Increase your usable space with a Monaco Linear Edge model. Ideal for alfresco dining, a straight edge means more seating under the canopy.

A fixed, straight-edge also adds the ability to attach guttering or roll-down blinds, making the structure even more versatile.

CONTOUR EDGE

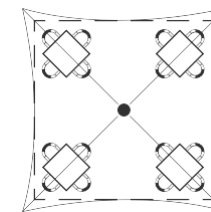

6m x 6m Canopy
29sqm of cover

LINEAR EDGE

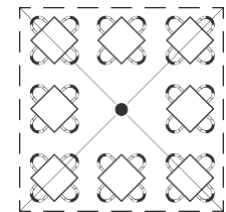

6m x 6m Canopy
36sqm of cover (26% more cover)

PAVILION MODULAR SHADE STRUCTURE

The Pavilion Modular Structure has perimeter columns in each corner, providing clear access under the full canopy area.

The perimeter columns have a lower foundation load compared to the Monaco and other central column structures, making it easier to install on existing slabs and ideal for integrating guttering and blinds.

Pavilion is perfect for outdoor dining areas, function spaces, and wedding venues. The Pavilion is also well suited to school assembly areas and playground shade, and multiple units can be joined together to create sheltered walkways.

- » Multiple units can be linked together to increase the shade and weather protected area.
- » Available in Contour Edge and Linear Edge.
- » Engineered as a permanent shade structure, Pavilion Modulares are designed for any Saudi Arabia wind speed.
- » Completely weather-proof, Pavilion Modulares include galvanised steel cables with stainless steel fittings and UV stabilised membrane.
- » Available with a range of accessories, such as LED lighting and heating.
- » Roll-down blinds and gutters can also be fitted to Pavilion Linear Edge models.

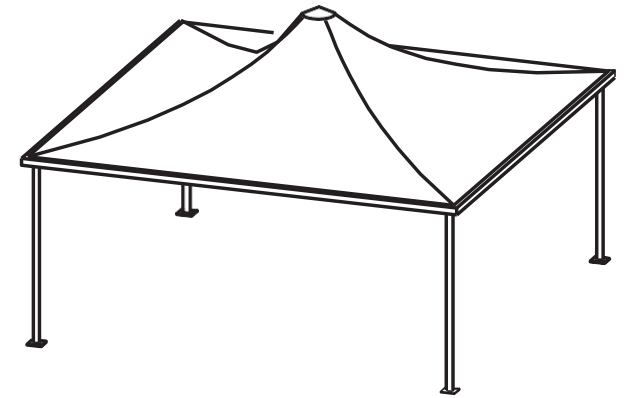

CONTOUR EDGE

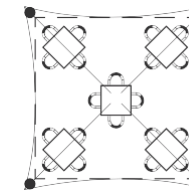

6m x 6m Canopy
29sqm of cover

LINEAR EDGE

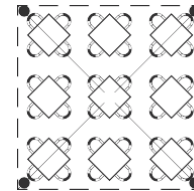



6m x 6m Canopy
36sqm of cover (26% more cover)

STANDARD SIZES

Single canopies range from 4m x 4m to 12m x 12m. Linking units together can create larger coverage.

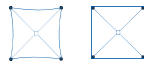
STANDARD SHAPES



CANOPY SHAPE / COLUMN	CANOPY SIZE	MODEL NUMBER
	m	Code (L-Linear Edge)
 PERIMETER COLUMN	4 x 4	PS40
	5 x 5	PS50
	6 x 6	PS60 / PS60L
	7 x 7	PS70 / PS70L
	8 x 8	PS80
	9 x 9	PS90
	10 x 10	PS100
	12 x 12	PS120

QUASAR MODULAR SHADE STRUCTURE

When you want shade with style, the Quasar Modular Structure utilises a 'hypar' design to create an aesthetically pleasing shade solution.

Popular with resorts, shopping centres, swimming pools and leisure centres, as well as community shade projects for parks and playgrounds, the Quasar comes in a range of sizes to suit the required shade protection.

The unique geometry of the Quasar is also attractive and eye catching when multiple units are installed in the same area.

- » Multiple units can be linked together to increase the shade and weather protected area.
- » Engineered as a permanent shade structure, Quasar Modulares are designed for any Saudi Arabia wind speed.
- » Completely weather-proof, Quasar Modulares include galvanised steel cables with stainless steel fittings and a UV stabilised membrane.
- » Lighting and electrical connectivity available.

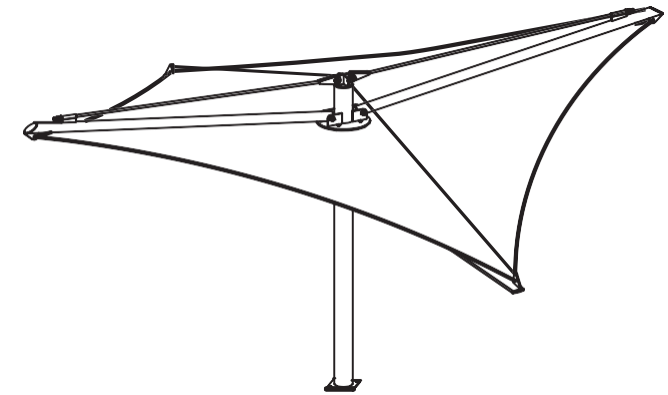

The Hyperbolic Paraboloid, or 'hypar' shape is used frequently in membrane shade structures.

The opposing high and low connection points help to hold the membrane under tension and create a strong, stable structure.

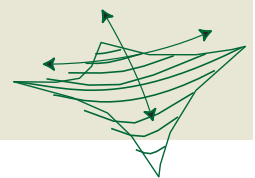

STANDARD SIZES

Single canopies range from 4m x 4m to 12m x 12m. Linking units together can create larger coverage.

STANDARD SHAPE



CANOPY SHAPE / COLUMN	CANOPY SIZE	MODEL NUMBER
	m	Code
 CENTRE COLUMN	4 x 4	QS40
	5 x 5	QS50
	6 x 6	QS60
	7 x 7	QS70
	8 x 8	QS80
	9 x 9	QS90
	10 x 10	QS100
	12 x 12	QS120

ST TROPEZ MODULAR SHADE STRUCTURE

The St Tropez Modular Structure is a unique inverted-umbrella style design and offers maximum visual impact in a pedestrian area or public space.

A popular choice for local councils, transport hubs, airports, retail centres, sports and recreation facilities, and resorts and theme parks, the inverted canopy provides a higher shade covering, creating a light open air under-canopy feel.

- » Multiple units can be linked together to increase the shade and weather protected area.
- » Engineered as a permanent shade structure, St Tropez Modulares are designed for any Saudi Arabia wind speed.
- » Completely weather-proof, St Tropez Modulares include galvanised steel cables with stainless steel fittings and UV stabilised membrane.
- » The inverted cone design enables rain water to be directed into hidden drainage in the centre of the column.
- » The raised edge height is great for overlapping adjacent structures or in area where high clearance is needed, such as transport infrastructure.

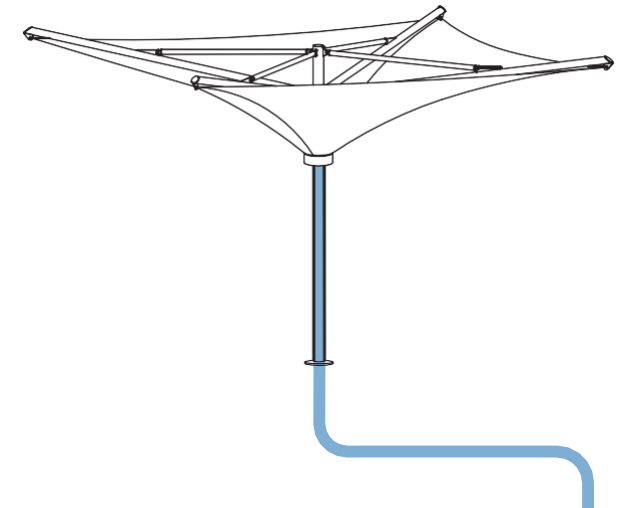

In addition to providing shade, the inverted cone of the St Tropez design collects storm water, which can then be plumbed into retention tanks, allowing redistribution of water for gardens or cleaning.

STANDARD SIZES

Single canopies range from 6m x 6m to 12m x 12m. Linking units together can create larger coverage.

STANDARD SHAPE



CANOPY SHAPE / COLUMN	CANOPY SIZE	MODEL NUMBER
	m	Code
 CENTRE COLUMN	6 x 6	ST60
	7 x 7	ST70
	8 x 8	ST80
	9 x 9	ST90
	10 x 10	ST100
	12 x 12	ST120

HELENA MODULAR SHADE STRUCTURE

One of our most exciting designs, the Helena Modular Structure is a circular, anticlastic saddle-like structure.

Supported by three lightweight V-shaped columns at the perimeter, Helena is a bright, open and airy structure, perfect for shading and weather proofing a school courtyard or covered outdoor learning area.

The wave-like upper curve can be positioned over the top of adjacent buildings.

Helena is also a star performer for outdoor stages and other public and community shade projects.

- » Engineered as a permanent shade structure, Helena Modulares are designed for any Australian wind speed.
- » Completely weather-proof, Helena Modulares include galvanised steel cables with stainless steel fittings and a UV stabilised membrane.
- » Helena has three lightweight V-shaped columns.
- » Lighting and electrical connectivity available.

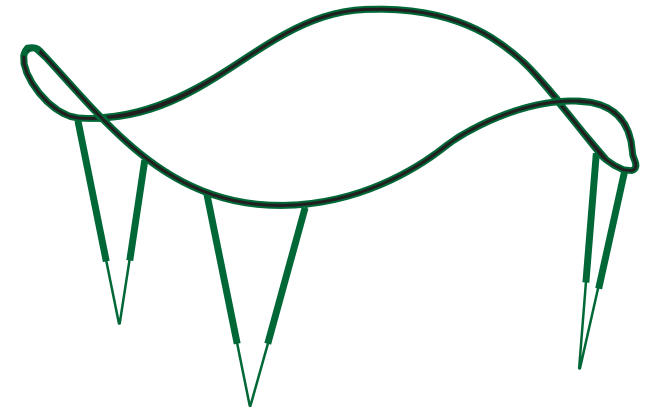

An anticlastic curved shape refers to a plane curved in opposite ways in two directions.

The most notable anticlastic forms are a Western-style saddle and a famous brand of snack food!



STANDARD SIZE

Canopy is 14m diameter.

STANDARD SHAPE



CANOPY SHAPE / COLUMN	CANOPY SIZE	MODEL NUMBER
	m (diameter)	Code
 PERIMETER COLUMN	14	HE140

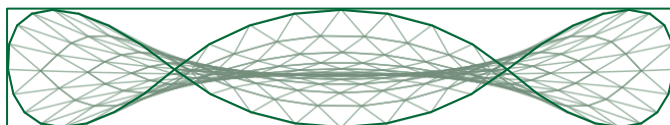



TENSOCAR CARPARK SHADE

The Baqar Shades TensoCar Carpark range caters for all types of commercial carpark shade and weather protection. Our range of architectural carpark shade installations offer effective protection from sunlight, rain, wind, hail and snow, with solutions to suit any application and environment.

From single and double bay designs for shopping centres and commercial parking lots, to mass vehicle coverage for fleet storage, Baqar Shades is the market leader in premium shade and weather protection for the automotive industry.

We are confident we have the most durable and longest-lasting carpark shade structures on the market.

Baqar Shades designs have been engineered to exacting tolerance, and every batch of fabric is stretch tested to ensure once installed, our carpark canopies never require re-tensioning throughout their lifespan.

This eliminates the need for toggles and threaded rods, which are the most common failure points we have seen when called to repair or reskin non-Baqar Shades carpark structures.



SINGLE BAY

The standard-arch Single Bay TensoCar Carpark shade protects a single row of parked cars. Ideal for smaller commercial property carparks or combined with Double Bay TensoCar Carpark shades to accommodate the outer edges of a retail parking area.

Available in White Architectural PVC or coloured HDPE Mesh.



DOUBLE BAY

The standard-arch Double Bay TensoCar Carpark shade accommodates rows of parked cars two deep.

The Double Bay design provides the most cost effective \$/space value for the retail market.

Available in White Architectural PVC or coloured HDPE Mesh.



DOUBLE BAY WITH WALKWAY

Double Bay TensoCar Carparks can be designed to include a walkway in between the parking bays. This design is popular when tied into primary shopping centre egress routes, improving weather protection for customers.

Available in White Architectural PVC or coloured HDPE Mesh.

TENSOCAR CARPARK SHADE

LINEAR EDGE CARPARKS

Available on both the Single Bay and Double Bay TensoCar carpark shade covers, the Linear Edge is our premium design solution. The additional supporting strut at the leading edge of the shade cover provides your parking location with a range of advantages, including;

- » A more robust structure – increased resistance to the impact of a collision.
- » Increased stability can increase the potential span, offering more coverage.
- » Additional guttering can assist collecting/channeling rainwater to recovery tanks. Decreased water flow onto the customer carpark space.
- » Rigid structure offers opportunity to incorporate signage, lighting or park assist.

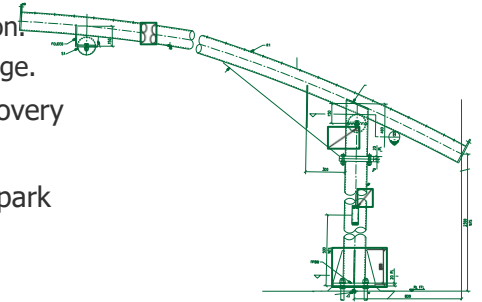

FULL COVER

Ideal for longer stay carpark at airports, or more exposed rooftop shopping centre carpark, Baqar Shades can design and engineer Full Cover TensoCar Carparks. An extended barrel-vault design, Full Cover carpark protect the whole parking aisle, both driveway and parking bays. Full Cover carpark structures can be built side-by-side to cover entire parking lots.



HYPAR

The Baqar Shades Hypar carpark shade sail provides large areas of cover that include parking bays, walkways and driveway areas. We use a HDPE (high density polyethylene) shade mesh for our Hypar carpark, offering sun, UV, and hail protection. HDPE shade mesh comes in a variety of colours offering your business more unique parking options.



BESPOKE CARPARK SHADE

Extending our range further, Baqar Shades is able to create custom designs to suit your needs. Our most popular bespoke carpark styles include the Hockey Stick (pictured) or the Y-Shaped carpark.

TENSONET HAIL PROTECTION

The Baqar Shades TensoNet HNPC (Hail Net Protection Canopy) system is adaptable for a range of mass cover applications from 1,000m² to 100,000m² coverage.

A Baqar Shades TensoNet HNPC provides hail protection for;

- » Vehicle Storage & Auction Yards.
- » Auto Dealers & Car Rental Companies.
- » Long-Term Airport Parking.
- » Building & Construction Companies.
- » 3rd Party Logistics Companies (3PL).
- » Original Equipment Manufactures (OEM).

Highly experienced in large scale industrial projects, our engineers have developed the Baqar Shades TensoNet HNPC system to create innovative design details which are specifically intended for use as vehicle hail protection structures.

FABRIC OPTIONS

Built specifically to protect your fleet from the worst weather nature can throw at it, Baqar Shades Hail Net Protection Canopies are made with the highest-quality materials. We offer two fabric options;

QUAD NET



ADVANTAGES OF QUAD NET

- » Provides adequate protection against hail.
- » Lower initial project cost.
- » Lower purchase cost.
- » Simplified installation process.
- » Easily removed and replaced.

HDPE MESH (SHADE CLOTH)

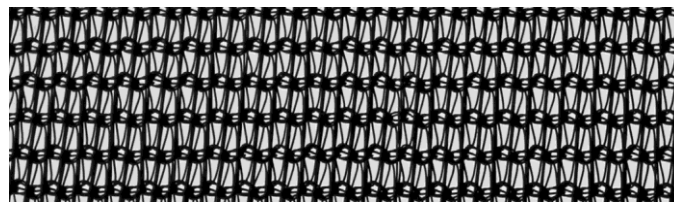

ADVANTAGES OF HDPE MESH (SHADE CLOTH)

- » Provides shade as well as excellent hail protection.
- » Fully engineered panels.
- » Subject to in-house QC.
- » Can be fabricated to any width, length, and shape.
- » Lower ongoing cost to client.

Our cantilevered column design means there are no guy cables or back-stays required, allowing our HNPC structures to maximise the protective cover by placing perimeter columns immediately adjacent to site boundaries.

The cable grid system allows for large spans and a relatively simple installation process, ensuring speedy installation and minimal site disruption.

If your business requires vehicle protection hail net, the Baqar Shades TensoNet HNPC system can provide a robust and economical hail risk-reduction solution.



MAKMAX ZERO GAP INTERFACES

Using a unique Zero Gap Interface system on all corners and membrane section connections ensures that there are no potential points of entry for damaging hail.

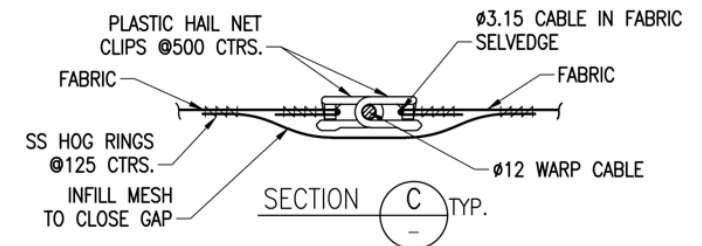

TENSONET HAIL PROTECTION



TENSONET HNPC STRUCTURE PROFILES

Our engineering team have developed a range of edge profiles to meet a variety of requirements.

FLAT ROOF

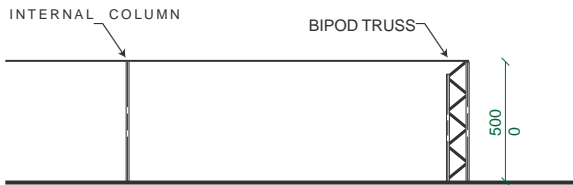

- » Usually range from 3m to 5m UCC.
- » Provides consistent clearance throughout.
- » 5m structures for high vehicles.

DROPPED SIDES

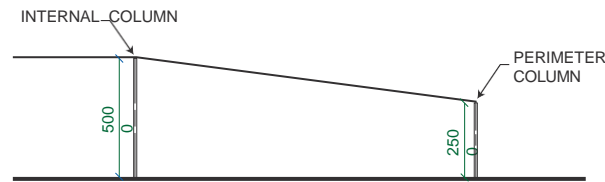

- » Internal clearance usually 5m.
- » Perimeter clearance usually 2.5 or 3m.
- » Allows for smaller footings and perimeter columns.

GUYED

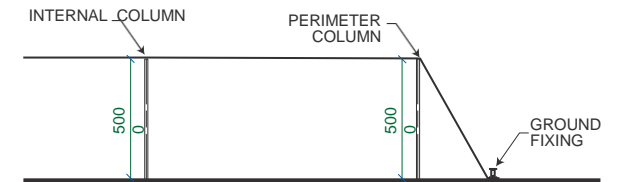

- » Internal clearance usually 3m – 5m
- » Allows for smaller footings and perimeter columns.
- » Requires more space for perimeter.



TENSOCOLA SCHOOL CANOPY

The addition of a covered outdoor learning area to a school can help or enhance the learning environment. The ability to take activities to the outdoors can foster greater learning and encourage student development, promoting a healthy, sun-safe outdoor experience.

Architectural membrane structures are especially suited to school shade projects, as they provide superior cooling properties to conventional roofing materials.

Baqar Shades can create a covered outdoor learning area to suit most climates, spaces or pavement surfaces. Our experience in creating unique playground spaces enables us to provide you with tensile membrane structures that enhance the experience of the whole area.

Baqar Shades can also design extensions and awnings to connect to other buildings, creating a truly weatherproof solution for the school yard.



THE Baqar Shades TENSOCOLA SCHOOL CANOPY

A pre-engineered structure with the ability to be adapted for any width, length, height and location, the Baqar Shades TensoCola School Canopy is our most popular shade cover for schools.

A traditional barrel-vault style canopy which provides a strong, safe structure, the Baqar Shades TensoCola School Canopy can easily be adapted for covering playgrounds, assembly areas and school swimming pools.

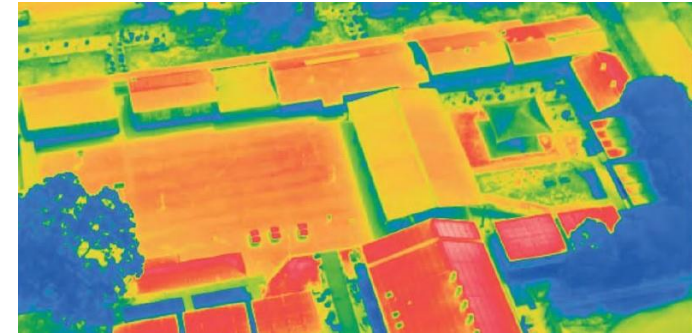

An aerial heatmap of a school in Parramatta. The green square in the courtyard shows the cooling effect of a membrane shade structure.

A membrane roof offers high light transmission (translucency), but effectively reflects heat.

On a 35°C day, the under-surface of a membrane roof will be up to 9°C cooler than a metal or slate roof.



St Peter's Lutheran College, Brisbane QLD



Mona Vale State School, NSW



St John's Catholic Parish Primary School, Dapto NSW

TENSOSPORT CANOPY

For council leisure centres, private and community sports clubs, and school sporting programs, a sports court canopy can be the hub for multiple sporting activities.

A translucent membrane roof is particularly suitable for sports court cover, as they provide an even, natural light with very little shadowing during the day. The use of tensile membrane canopies can also assist in maintaining air flow, while still providing effective sun and weather protection.

Our long history of creating award-winning sports structures clearly demonstrates our capability and understanding of the varying needs of different sports. From knowing the height requirements of a basketball backboard to understanding the depth of court coverage required behind the tennis baseline, we take your sporting stats into account in all our designs.

THE Baqar Shades TENSOSPORT CANOPY

The Baqar Shades TensoSport Canopy is a larger version of our Tensocola School Canopy. Able to cover larger spans without any internal pillars, this canopy is perfectly suited to all forms of sports facility shade and weather protection.

The Baqar Shades TensoSport Canopy has been installed in education facilities, as well as private and community sports clubs for a range of sporting applications.

- » Basketball/Netball Courts.
- » Tennis Courts.
- » Swimming Pools.
- » Futsal fields (synthetic surface).
- » Hockey pitches (synthetic surface).



Increase the usability of your Baqar Shades TensoSport Canopy with the inclusion of LED lighting, perfect for evening practice or playing on rainy days. Using computer modeling, we can create lighting level to any required LUX.

Customise your sports court canopy with further integrations including; side-nets, netball hoops, basketball backboards, scoreboards, PA systems, and player-safety padding around columns.



TENSOSPORT-MAX CANOPY

PREMIUM SPORTING CANOPIES

We have built a reputation as sporting canopy specialists over the last decade, transforming the amenities, comfort and landscape of many professional and community sporting clubs across the country. We maintain a focus on continuous improvement and refinement of our large span TensoSport-MAX designs, driven by listening to our customers and the sporting community and responding to their needs and wants. Boasting a range of tried and tested canopy styles, designed and engineered by Baqar Shades Saudi Arabia in-house team of technical experts, we can customise each and every detail for your club. Our premium sports canopy solution, TensoSport-MAX are offered in a range of designs;

THE FLATBACK (BARREL VAULT DESIGN)

Parallel arches and perpendicular struts create a clean, simple and efficient roof covering with a natural barrel-vaulted fabric shape.

THE LOGGERHEAD (VERTICAL ARCHED PEAK DESIGN)

Contrasting peaked central arches with valley cables and ribbed arched struts around the perimeter, this canopy style feels incredibly lightweight and open.

THE HAWKSBILL (LEANING ARCHED DESIGN)

This striking visual design employs leaning arches and valley cables to create the exciting sawtooth profile.



BESPOKE DESIGN OPTIONS

Baqar Shades Saudi Arabia engineers and designers take a wide range of factors into account, including soil reports, sun studies, annual rainfall studies, wind simulations, the amount of natural light and/or any local council requirements to customise the most suitable long-lasting shade.



Gutters
Drainage
Shutters / Blinds



LED Lights
Audio/PA Systems
Scoreboards

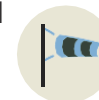

Low-end profiles
Wind-rated steel



Infrared / Gas Heaters





VELARIUM VARIABLE SHADE SYSTEM

CHOOSE YOUR AMOUNT OF SHADE

The Baqar Shades Velarium is an advanced motorised retractable shade system. Opposing sets of PVC mesh panels, supported by a steel structure and cable grid, place the power of the sun (the amount of shade required) into the hands of the user.

The system can be operated directly from a master control panel or a remote control unit. Each Velarium shade section is retracted and deployed by an independent motor, giving the operator the flexibility to open or close individual panel sections to suit their requirements. This clever design allows for panels to be deployed in almost any position between fully open and fully closed, and can be controlled by a single person.

The system is backed by series of safety measures, including pre-set and constant monitoring limit/control switches, along with climate sensors designed to retract the shade automatically when high winds are detected.

The Baqar Shades Velarium variable shade system is an adaptable system that would suit any application requiring large span, column-free variable shade. The Velarium variable shade system is suited to grass sporting facilities where a full canopy would not allow enough sunlight to filter to the playing surface.

Perfectly suited for swimming pools, where some sunlight is still welcome, the Baqar Shades Velarium variable shade system.



DESIGN FLEXIBILITY

Baqar Shades is proud to be able to offer design flexibility. All our Standard and Modular products can be customised to meet the most challenging project brief, whilst delivering a solution that is both timely and cost effective.

Flexibility is a hallmark of the Baqar Shades Range.

- » We can adapt the size and shape of most of our designs.
- » We can link structures together to create a larger single canopy area.
- » Choose your fabric, from HDPE shade mesh to durable and weatherproof PVC, or opt for premium long-life PTFE.
- » Add colour to your structure - both fabric and steel.
- » Include LED lighting, PA systems, Park Assist or Scoreboards.
- » Add or include gutters, downpipes and plumbing.
- » We can increase steel column widths for tropical weather regions or higher wind zones.

The Baqar Shades team believes in limitless possibilities and our designs and engineering teams specialise in bringing your project aspirations to life. Talk to us about your ideal shade structure and we'll create a bespoke solution for you.



REPAIRS, REPLACEMENTS & MAINTENANCE

To maximise the lifespan and maintain the warranty of your tensile membrane structure, a regular routine inspection and maintenance program will help identify potential environmental impacts and standard wear and tear.

Our commitment to clients extends beyond the project completion date with a range of additional services offered throughout the life of the structure.

Baqar Shades POST PROJECT SERVICES

- » Routine Engineering Inspections & Reports.
- » Warranty Inspections.
- » Programmed Cleaning & Maintenance.
- » Engineering Repairs.
- » Membrane Repairs, Re-skins or Replacements.

ROUTINE ENGINEERING INSPECTIONS & REPORTS

Baqar Shades tensile membrane structures are designed to be long-lasting and low maintenance, however we recommend ongoing engineering inspections at least every 3 years, or after any severe weather event. We offer detailed maintenance inspections and reports by our qualified building inspectors and/or structural engineers for a small fee.

WARRANTY INSPECTIONS

Most of our fabric manufactures stipulate regular maintenance inspections by an engineer or qualified person in order for the membrane warranty to remain valid. Baqar Shades offers these services through our in-house building inspectors and structural engineers.

PROGRAMMED CLEANING & MAINTENANCE

While tensile membranes offer greater 'self-cleaning' properties than other roofing materials, various environmental impacts, dust in rural areas or pollution in urban areas and surrounding foliage can cause contaminant build up. Baqar Shades can arrange cleaning of your membrane roof directly through our partner subcontractors.



ENGINEERING REPAIRS

With appropriate maintenance, structural steel and hardware components in your structure are designed to last for the expected life of your project. Should any structural element begin to show damage through environmental influence or external impacts, it is important to have those sections replaced or repaired, along with a full engineering analysis of the structure to confirm the tensioned membranes are safe.

MEMBRANE REPAIRS, RE-SKINS OR REPLACEMENTS

The various membranes used by Baqar Shades offer different life-spans depending on their quality and construction, and from time to time, external factors may cause damage to the membrane structure. Baqar Shades can inspect your membrane and propose a solution to either repair or replace the membrane. In many cases the supporting steel frame can be kept in-situ and the replacement costs can be quite economical.



TYPES OF DAMAGE



STORM DAMAGE



IMPACT



DUST/POLLUTION



VANDALISM

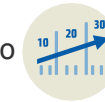

EXPECTED LIFESPAN



FIRE

INDUSTRY APPLICATIONS

Pushing the boundaries of engineering and design, our commercial shade structures are aesthetically beautiful, elegant and iconic, and adaptable to a wide-range of applications. Our commitment is to meet your needs and exceed your expectations – regardless of your industry or specific project requirements.

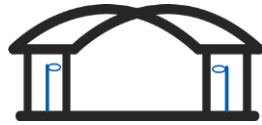

SPORTS &
RECREATION



RETAIL &
COMMERCIAL



SCHOOLS &
UNIVERSITIES



HOSPITALITY &
TOURISM

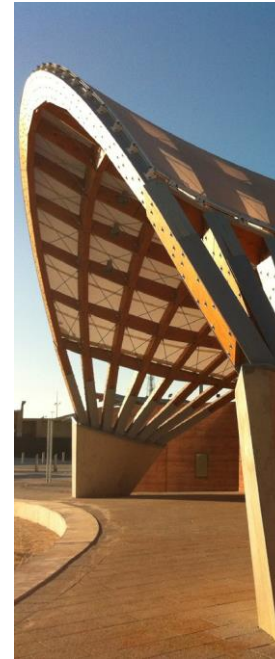

GOVERNMENT &
LOCAL COUNCIL





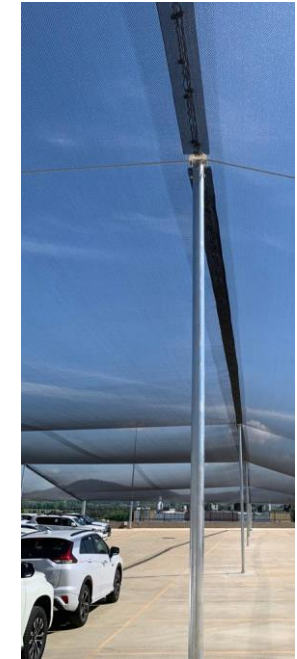







TRANSPORT &
INFRASTRUCTURE



INDUSTRIAL,
MINING &
AGRICULTURE

ARCHITECTURAL FABRIC COMPARISON

Baqar Shades uses only the very best fabrics, sourced directly from some of the world's best membrane manufacturers. While there are many manufacturers and products available within each material type, Baqar Shades only use materials from premium quality suppliers. Our expert knowledge, continued research and development and in-house fabrication of our projects, ensure your fabric structure or tensile membrane project is delivered beyond your expectations.

	HDPE Shade Cloth	PVC Polyester Open Weave Mesh	PVC Coated Polyester	PTFE Teflon Coated Open Weave Mesh	PTFE Teflon Coated Fibreglass
 Means of Fabrication	Sewing/Overlocking	RF Welding	RF Welding	Heat Sealing	Heat Sealing
 Life Expectancy (years)	10+	20+	20+	45+	45+
 Translucency	3-50% Colour dependent	5-40%	6-8%	30-40%	12-15%
 Waterproof	✗	✗	✓	✗	✓
 UV Protection	●●	●	●●	●	●●●
 Cleanability	●●	●●	●●	●●	●●●
 Recyclable	✗	✓	✓	✗	✗
 Colours Options	Large colour range	Large colour range	Large colour range (Umbrellas) / Limited colour range (large structures)	Limited colour range	White only (after sun bleaching)
 Maintains Colour	Dependent on colour	Some yellowing over time may occur	Some yellowing over time may occur	✓	✓
 Price Comparison	●	●●	●●	●●●	●●●
 Additional Options Available	Different knit patterns available for strength and density of weave	Top coats in fluropolymers and TiO2 coatings to improve durability & surface cleanliness	Top coats in fluropolymers and TiO2 coatings to improve durability & surface cleanliness	Top coats in fluropolymers and TiO2 coatings to improve durability & surface cleanliness	Top coats in fluropolymers and TiO2 coatings to improve durability & surface cleanliness

The Fabric Comparison Table is provided as a guide only, individual project details, such as environment, application and the brand of fabric will be considered when selecting a fabric for your structure.



Baqar Shades is the market leader in the design, engineering, fabrication and installation of Architectural Umbrellas, Standard and Modular Shade Structures and Custom Fabric Structures for a variety of applications. We combine architectural designs with engineering solutions, ensuring your project quality is second to none.

THE Baqar Shades DIFFERENCE;

- » We provide you with an in-house engineering and design team.
- » Global Reputation, Local Expertise; operating in Saudi Arabia for over 23 years, Baqar Shades is also part of the Saudi Arabia Group, global leaders in tensile membrane structures.
- » A Commitment to Quality, Safety and the Environment; ISO certification ISO 9001, ISO 14001, ISO 45001.

For more information on our capability and design solutions contact our team.

Design. Engineer. Fabricate. Install.

Baqar Shades Saudi Arabia

0594240333 | info@baqarshades.com | www.baqarshades.com

